



U.S. Department
of Transportation

**National Highway
Traffic Safety
Administration**

400 Seventh Street, S.W.
Washington, D.C. 20590

Dear Crash Data Researchers/Users:

Thank you for choosing crash data from the National Highway Traffic Safety Administration (NHTSA) for your research or other use. The information contained in this motor vehicle crash report is collected, maintained and distributed in accordance with Public Law 89-564. In accordance with this Public Law, NHTSA is required not to release any case information until completion of quality control procedures. These procedures include a review of the case material to extract all names, licenses and registration numbers, non-coded interview material, non-research related researcher comments in the margins, non-factual data, and the production number portion of the vehicle identification number (VIN).

If you requested NHTSA to query its database files in order to identify a specific crash, then that query was made using non-personal descriptors you provided for use in our search. This motor vehicle crash may have been identified from a data search and matches the general, non-personal descriptors you provided, but we cannot confirm that this is the specific crash report you requested.

If you have any questions with regard to the above procedures, please contact the Field Operations Branch, Crash Investigation Division, National Center for Statistics and Analysis at 202-366-4820. Again, please be advised that we cannot confirm that this is the case that you have specifically requested nor can we certify the information to be correct.

*** **



AUTO SAFETY HOTLINE
(800) 424-9393
Wash. D.C. Area 366-0123



PEDESTRIAN CASE SUMMARY

PSU 82 CASE NO. 601 P TYPE OF ACCIDENT CAR TURNING LEFT/PEDESTRIAN WALKING

A. DESCRIPTION OF THE ACCIDENT SEQUENCE AND ACCIDENT PECULIARITIES

(Provide a summary of the accident sequence as well as any particular event of the accident that is noteworthy. Pedestrian injury mechanism and vehicle interaction is the focus, not pedestrian or driver culpability. Do not include any personal identifiers.)

Vehicle #1 was in lane 2 of a 4-lane, 2-way street and entered an intersection waiting for opposite traffic to clear and began a left turn onto a 2-lane, 2-way street. The front of Vehicle #1 impacted a pedestrian walking east bound in the crosswalk. The pedestrian went onto the hood and fell off to the right side fender area to the ground. Vehicle #1 was stopped approximately one-half car length over the crosswalk.

B. PEDESTRIAN PROFILE

Pedestrian No.	Age	Sex	Treatment/Mortality	Most Severe Injury (TO BE COMPLETED BY ZONE CENTER)			
				Body Region	Ana. Struc.	AIS	Injury Source
01	13	Female	Treated & released	External	Skin-Other	1	non-contact injury source

Body Region	Type of Anatomic Structure	Abbreviated Injury Scale
Head	Whole Area	(1) Minor injury
Face	Vessels	(2) Moderate injury
Throat	Nerves	(3) Serious injury
Chest	Organs	(4) Severe injury
Abdomen/Pelvis	Skeletal	(5) Critical injury
Spine	Head-LOC	(6) Maximum (untreatable)
Upper Extremity	Skin-Burn	(7) Injured, unknown severity
Lower Extremity	Skin-Other	
External		

C. VEHICLE PROFILE

Vehicle No.	Class of Vehicle	Year/Make/Model	Most Severe Damage Based on Vehicle Inspection	
			Damage Plane	Damage Description
01	Subcompact	92/Toyota/Paseo	Front	Minor - smears, scratches

DO NOT SANITIZE THIS FORM

ACCIDENT COLLISION DIAGRAM

PSU No. 82
Case Number - Stratum 601 P

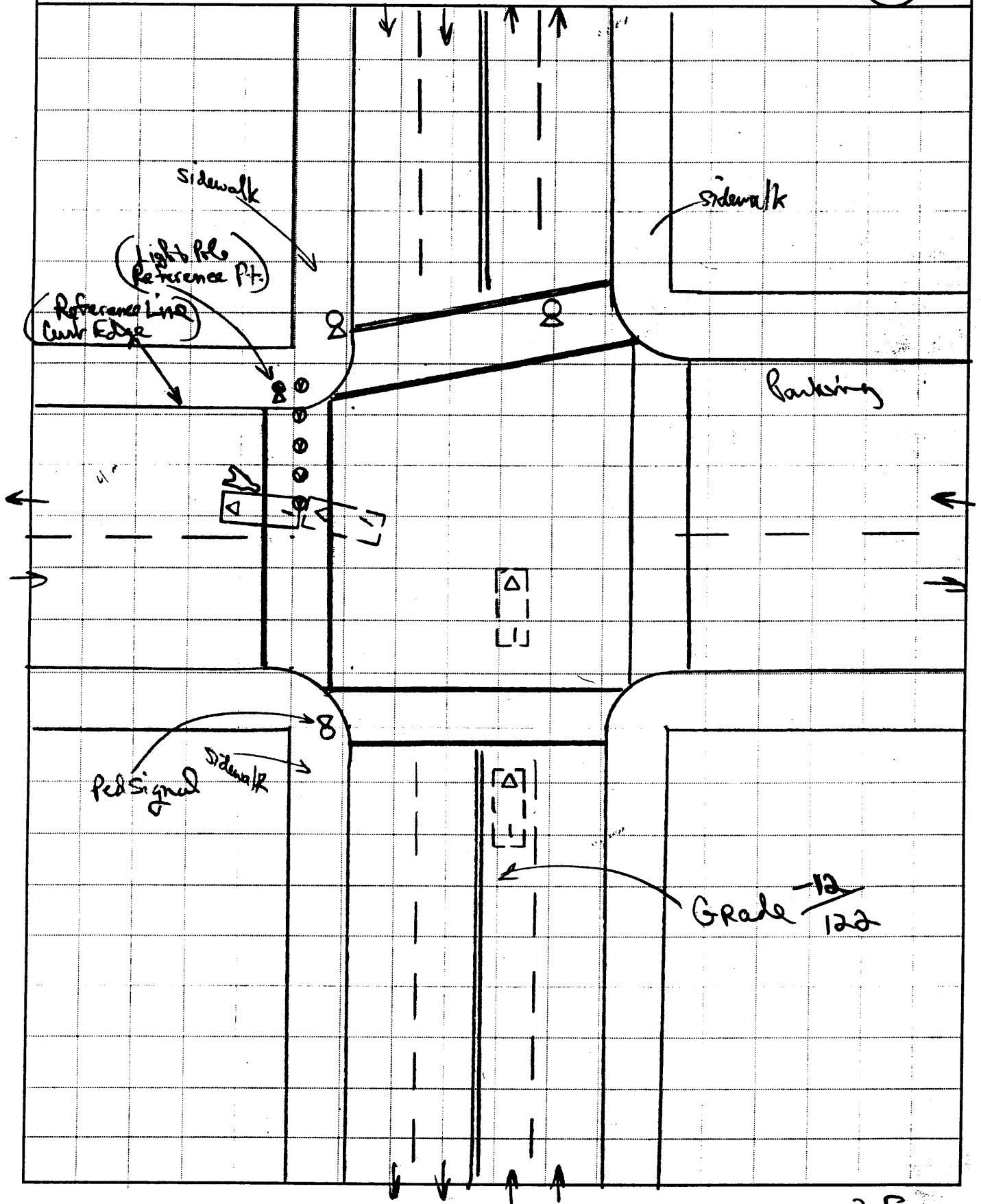



U.S. Department of Transportation
 National Highway Traffic Safety
 Administration

ACCIDENT COLLISION DIAGRAM

NATIONAL ACCIDENT SAMPLING SYSTEM
 CRASHWORTHINESS DATA SYSTEM

PSU No. 82 Case Number - Stratum 601P

Indicate North 

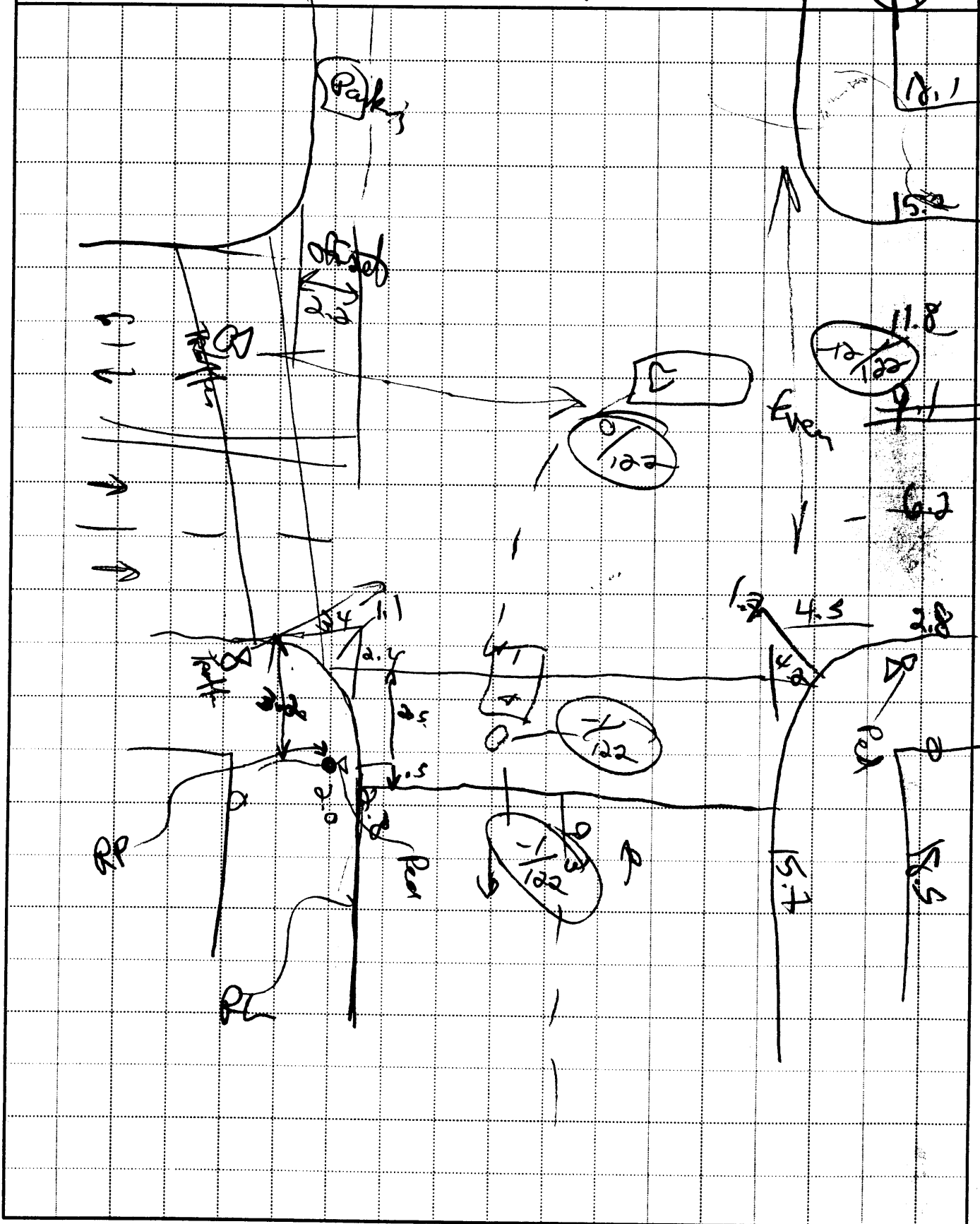



PEDESTRIAN ACCIDENT COLLISION MEASUREMENT TABLE

Primary Sampling Unit Number 82

Case Number-Stratum 6 0 1 P

PEDESTRIAN ACCIDENT COLLISION DATA COLLECTION		SCALED DIAGRAM
* document reference point and reference line relative to physical features	Surface Type <u>Asphalt</u>	* north arrow placed on diagram
* documentation of all accident induced physical evidence including (if applicable):	Surface Condition <u>Dry</u>	* grade measurements for all applicable roadways
	Coefficient of Friction <u>0.65</u>	* scaled representations of the physical plant including:
a) vehicle skid marks	Grade (v/h) Measurement	a) all road/roadway delineation (e.g., crosswalks, curb/edge lines, lane markings, medians, pavement markings, parked vehicles, poles, signs, etc.)
b) pedestrian contacts with ground or object	a) at impact <u>-1/122</u>	b) all traffic controls (e.g., lights, signs)
c) vehicle/pedestrian point of impact (POI)	b) between impact and final rest <u>-1/122</u>	* scaled representations of the vehicle and pedestrian at pre-impact, impact, and final rest based upon either:
d) location of pedestrian separation point from vehicle	Pedestrian Travel Direction <u>North</u>	a) physical evidence, or
f) final resting points (FRP) for pedestrian and vehicle	Vehicle Travel Direction <u>South</u>	b) reconstructed accident dynamics
* documentation of the physical plant including:	Number of Travel Lanes <u>4</u>	
a) all road/roadway delineation (e.g., crosswalks, curb/edge lines, lane markings, medians, pavement markings, parked vehicles, poles, signs, etc.)		
b) all traffic controls (e.g., lights, signs)		

Reference Point: Light Pole at South West Corner of Intersection

Reference Line: West Curb Edge

Item	Distance and Direction from Reference Point	Distance and Direction from Reference Line
<u>NONE</u>		



PEDESTRIAN ACCIDENT FORM

1. Primary Sampling Unit Number 82
2. Case Number - Stratum 601P

SPECIAL STUDIES - INDICATORS

Check (✓) each special study (SS15-SS19 below) that has been completed; code 1 for the checked special studies and 0 for the special studies not checked.

IDENTIFICATION

3. Number of General Vehicle Forms Submitted 0 1
4. Date of Accident (Month, Day, Year) [REDACTED] 9 6
5. Time of Accident 1450 ✓
Code reported military time of accident.
NOTE: Midnight = 2400
Unknown = 9999

6. ___ SS15 Administrative Use 0
7. SS16 Pedestrian Crash Data Study 1
8. ___ SS17 Impact Fires 0
9. ___ SS18 _____ 0
10. ___ SS19 _____ 0

NUMBER OF EVENTS

11. Number of Recorded Events in This Accident 0 1

PEDESTRIAN STUDY CRITERIA

Pedestrian Definition:

Any person who is on a trafficway or on a sidewalk or path contiguous with a trafficway, or on private property (e.g., parking lot). Note: Pedestrians include persons who are in contact with the ground, roadway, etc. and are pushing carts, wagons, etc. or holding on to a vehicle.

Persons in or on a nonmotorist conveyance are not pedestrians and are excluded from this study. A nonmotorist conveyance is defined as any human powered device by which a nonmotorist may move, or by which a pedestrian or nonmotorist may move another nonmotorist. A nonmotorist conveyance for purposes of this study includes the following: bicycles, baby carriages, roller skates/blades, push carts, scooters, wheelchairs, animals, etc. For example, persons on a bicycle/scooter, roller skating/blading, in a baby carriage/push cart/wheelchair or on a horse are excluded.

Case Selection Criteria:

A forward moving, late model year (VEH04 equals 90 to 95) CDS applicable vehicle (VEH07 equals 01 to 49) must strike a pedestrian.

The striking portion of the vehicle structure must be original equipment manufacturer (OEM) without previous damage and or parts removed in the impact area. For example, vehicles equipped with deer guards, winches, snow plows, etc. or previously damaged in the impact area are excluded.

The pedestrian may not be lying or sitting.

The pedestrian impact(s) are the vehicle's only impact(s). If multiple pedestrians are impacted, each pedestrian shall be a separate case.

The first point of contact between the late model year, CDS applicable vehicle and the pedestrian must be forward of the top of the A pillar.

PEDESTRIAN ACCIDENT EVENTS

Accident Event Sequence Number	Vehicle Number	Class Of Vehicle	General Area of Damage	Vehicle Number or Object Contacted	Class Of Vehicle	General Area of Damage
12. <u>0 1</u>	13. <u>0 1</u>	14. <u>01</u>	15. <u>F</u>	16. <u>7 2</u>	17. <u>0 0</u>	18. <u>0</u>

**CODES FOR
CLASS OF VEHICLE**

- (00) Not a motor vehicle
- (01) Subcompact/mini (wheelbase < 254 cm)
- (02) Compact (wheelbase ≥ 254 but < 265 cm)
- (03) Intermediate (wheelbase ≥ 265 but < 278 cm)
- (04) Full size (wheelbase ≥ 278 but < 291 cm)
- (05) Largest (wheelbase ≥ 291 cm)
- (09) Unknown passenger car size
- (11) Compact utility vehicle
- (12) Large utility vehicle (≤ 4,500 kgs GVWR)
- (13) Passenger van (≤ 4,500 kgs GVWR)
- (14) Other van (≤ 4,500 kgs GVWR)
- (15) Pickup truck (≤ 4,500 kgs GVWR)
- (18) Other truck (≤ 4,500 kgs GVWR)
- (19) Unknown light truck type

**CODES FOR GENERAL AREA
OF DAMAGE (GAD)**

**CDS APPLICABLE
VEHICLES**

- (F) Front
- (R) Right side
- (L) Left side
- (U) Undercarriage
- (9) Unknown

CODES FOR VEHICLE NUMBER OR OBJECT CONTACTED

Collision with Nonfixed Object

- (72) Pedestrian



PEDESTRIAN ASSESSMENT FORM

1. Primary Sampling Unit Number <u>82</u> 2. Case Number - Stratum <u>601P</u> 3. Pedestrian Number <u>01</u>	10. Pedestrian's Weight Code actual weight to the nearest kilogram. (999) Unknown <u>75</u> pounds X .4536 = _____ kilograms <u>034</u>
---	---

PEDESTRIAN'S CHARACTERISTICS	PEDESTRIAN'S PRE-AVOIDANCE ACTIONS
------------------------------	------------------------------------

4. Pedestrian's Age Code actual age at time of accident. (00) Less than one year old (specify by month): <u>13</u> (97) 97 years and older (99) Unknown 5. Pedestrian's Sex <u>F</u> (1) Male (2) Female - not reported pregnant (3) Female - pregnant-1st trimester (1st-3rd month) (4) Female - pregnant-2nd trimester (4th-6th month) (5) Female - pregnant-3rd trimester (7th-9th month) (6) Female - pregnant-term unknown (9) Unknown 6. Pedestrian's Overall Height Code actual height to the nearest centimeter. (999) Unknown <u>147</u> _____ inches X 2.54 = <u>147</u> <i>infield</i> centimeters 7. Pedestrian's Height - Ground to Knee Code to the nearest centimeter. (999) Unknown <u>46</u> _____ inches X 2.54 = _____ centimeters 8. Pedestrian's Height - Ground to Hip Code to the nearest centimeter. (999) Unknown <u>082</u> _____ inches X 2.54 = _____ centimeters 9. Pedestrian's Height - Ground to Shoulder Code to the nearest centimeter. (999) Unknown <u>127</u> _____ inches X 2.54 = _____ centimeters	11. Pedestrian Attitude <u>+</u> (1) Standing (2) Crouching (3) Kneeling (4) Bending at waist (8) Other (specify): _____ (9) Unknown 12. Pedestrian Motion <u>1</u> (0) Not moving (1) Walking slowly (2) Walking rapidly (3) Running - jogging (4) Hopping (5) Skipping (6) Jumping (7) Falling/stumbling or rising (8) Other (specify): _____ (9) Unknown 13. Pedestrian's Action Relative to Vehicle <u>01</u> (00) Stopped (01) Crossing road, straight (02) Crossing road, diagonally (03) Moving in road, with traffic (04) Moving in road, against traffic (05) Off road, approaching road (06) Off road, going away from road (07) Off road, moving parallel (08) Off road, crossing driveway (09) Off road, moving along driveway (98) Other (specify): _____ (99) Unknown 14. Pedestrian's Body (Chest) Orientation Relative to Striking Vehicle Prior to Avoidance Actions <u>W</u> (1) Facing vehicle (2) Facing away (3) Left side to vehicle (4) Right side to vehicle (8) Other (specify): _____ (9) Unknown
---	--

PEDESTRIAN'S AVOIDANCE ACTIONS15. Pedestrian's First Avoidance Actions 01

- (00) No avoidance actions
- (01) Stopped
- (02) Accelerated pace
- (03) Ran away (along vehicle path)
- (04) Jumped
- (05) Turned toward vehicle
- (06) Turned away from vehicle
- (07) Dove or fell away

Used hand(s) to :

- (11) Vault corner of vehicle
- (12) Vault onto vehicle
- (13) Brace against vehicle
- (14) Crouched and braced hands against vehicle
- (98) Other (specify): _____
- (99) Unknown

PEDESTRIAN'S ORIENTATION AT IMPACT16. Pedestrian's Head Orientation at Initial Impact 2

- (1) To front
- (2) To left
- (3) To right
- (4) Up
- (5) Down
- (8) Other (specify): _____
- (9) Unknown

17. Pedestrian's Body (Chest) Orientation at Initial Impact 3

- (1) Facing vehicle
- (2) Facing away
- (3) Left side to vehicle
- (4) Right side to vehicle
- (8) Other (specify): _____
- (9) Unknown

18. Pedestrian's Arm Orientation at Initial Impact 06

- (01) At sides
- (02) Folded across chest
- (03) Hands clasped behind back
- (04) Hands on hips
- (05) Hands in pockets

One or both arms:

- (06) Extended upward *holding soft drink*
- (07) Extended to side
- (08) Extended forward bracing
- (09) Extended, holding object (briefcase, suitcase, etc.)
- (10) Holding object (young child, grocery bag, etc.) in arm(s)
- (11) Holding object (young child, grocery bag, etc.) on shoulder(s) or head
- (98) Other (specify): _____
- (99) Unknown

19. Pedestrian's Leg Orientation at Initial Impact 04

- (01) Together
- (02) Apart-laterally
- (03) Apart-right leg forward
- (04) Apart-left leg forward
- (05) Apart- forward leg unknown
- (06) Left foot off the ground
- (07) Right foot off the ground
- (08) Both feet off the ground
- (98) Other (specify): _____ 01
- (99) Unknown

20. Vehicle/Pedestrian's Interaction 10

- (01) Carried by vehicle, wrapped position
- (02) Carried by vehicle, slid to windshield
- (03) Carried by vehicle, position unknown
- (04) Passed over vehicle top
- (05) Thrown straight forward
- (06) Thrown forward and left of vehicle
- (07) Thrown forward and right of vehicle
- (08) Knocked to pavement, forward
- (09) Knocked to pavement, left of vehicle
- (10) Knocked to pavement, right of vehicle
- (11) Knocked to pavement, run over or dragged by vehicle
- (12) Shunted to left (corner impacts only)
- (13) Shunted to right (corner impacts only)
- (14) Bumped or pushed aside
- (15) Snagged, rotated
- (16) Snagged, dragged by vehicle
- (17) Foot or legs run over
- (98) Other (specify): _____
- (99) Unknown

OFFICIAL RECORDS	INJURY CONSEQUENCES
<p>21. Police Reported Alcohol Presence For Pedestrian ☺</p> <p>(0) No alcohol present (1) Yes alcohol present (7) Not reported (9) Unknown</p>	<p>25. Injury Severity (Police Rating) 1</p> <p>(0) O - No injury (1) C - Possible injury (2) B - Nonincapacitating injury (3) A - Incapacitating injury (4) K - Killed (5) U - Injury, severity unknown (6) Died prior to accident (9) Unknown</p>
<p>22. Alcohol Test Result For Pedestrian Code actual value (decimal implied before first digit—0.xx) 96</p> <p>(95) Test refused (96) None given (97) AC (Alcohol Content) test performed, results unknown (99) Unknown if test given</p> <p>Source: <u>PAR</u></p>	<p>26. Treatment - Mortality 4</p> <p>(0) No treatment (1) Fatal (2) Fatal - ruled disease (specify): _____</p> <p><i>Nonfatal</i></p> <p>(3) Hospitalization (4) Transported and released (5) Treatment at scene - non-transported (6) Treatment later (8) Treatment - other (specify): _____</p> <p>(9) Unknown</p>
<p>23. Police Reported Other Drug Presence For Pedestrian ☺</p> <p>(0) No other drug(s) present (1) Yes other drug(s) present (7) Not reported (9) Unknown</p>	<p>27. Type Of Medical Facility (for Initial Treatment) 2</p> <p>(0) Not treated at a medical facility (1) Trauma center (2) Hospital (3) Medical clinic (4) Physician's office (5) Treatment later at medical facility (8) Other (specify): _____ (9) Unknown</p>
<p>24. Other Drug Specimen Test Result For Pedestrian ☺</p> <p>(0) No specimen test given (1) Drug not found in specimen (2) Drug found in specimen, (specify): _____ (3) Specimen test given, results unknown or not obtained (9) Unknown</p>	<p>28. Hospital Stay 00</p> <p>(00) Not Hospitalized _____ Code the number of days (up through 60) that the pedestrian stayed in a hospital. (61) 61 days or more (99) Unknown</p>
	<p>29. Working Days Lost 97</p> <p>_____ Code the number of days (up through 60) that the pedestrian lost from work due to the accident</p> <p>(00) No working days lost (61) 61 days or more (62) Fatally injured (97) Not working prior to accident (99) Unknown</p>

STOP - VARIABLES 30 THROUGH 37 ARE COMPLETED BY THE ZONE CENTER

30. Glasgow Coma Scale (GCS) Score 02
 (at Medical Facility)
 (00) Not injured
 (01) Injured - not treated at medical facility
 (02) No GCS Score at medical facility
 (03-15) Code the actual value of the initial GCS Score recorded at medical facility.
 (97) Injured, details unknown
 (99) Unknown if injured

31. Was the Pedestrian Given Blood? 1
 (1) No - blood not given
 (2) Yes - blood given
 (specify units): _____
 (9) Unknown if blood given

32. Arterial Blood Gases (ABG) – HCO₃ 01
 (00) Not injured
 (01) Injured, ABGs not measured or reported
 (02-50) Code the actual value of the HCO₃
 (96) ABGs reported, HCO₃ unknown
 (97) Injured, details unknown
 (99) Unknown if injured

33. Time to Death 00
 _____ Code number of hours from time of accident to time of death up through 24 hours. If time of death is greater than 24 hours, code number of days. (Note: 1 day = 31, 2 days = 32, ... n days = 30 + n up through 30 days = 60)
 (00) Not fatal
 (96) Fatal - ruled disease
 (99) Unknown

34. 1st Medically Reported Cause of Death 00

35. 2nd Medically Reported Cause of Death 00

36. 3rd Medically Reported Cause of Death 00

_____ Code the Pedestrian Injury from line number(s) for the medically reported injury(s) which reportedly contributed to this pedestrian's death
 (00) Not fatal or no additional causes
 (96) Mode of death given but specific injuries are not linked to cause of death. (specify): _____
 (97) Other result (includes fatal ruled disease) (specify): _____
 (99) Unknown

37. Number of Recorded Injuries for This Pedestrian 02

_____ Code the actual number of injuries recorded for this pedestrian.
 (00) No recorded injuries
 (97) Injured, details unknown
 (99) Unknown if injured

ARE ALL APPLICABLE MEDICAL RECORDS INCLUDED WITH INITIAL SUBMISSION?

NO [] YES []

UPDATE CANDIDATE? NO [] YES []



PEDESTRIAN INJURY FORM

1. Primary Sampling Unit Number 82	3. Pedestrian Number 0 1
2. Case Number - Stratum 6 0 1 P	4. Blank X X

INJURY DATA

Record below the actual injuries sustained by this pedestrian in **CHRONOLOGICAL** order that were identified from the official and unofficial data sources. Remember not to double count an injury just because it was identified from two different sources. If greater than twenty-five injuries have been documented, encode the balance on the Pedestrian Injury Supplement.

	AIS-90								Injury Source	Injury Confidence Level	Direct/Indirect Injury	Striking Profile	Type Of Damage	Damage Depth
	Source of Injury Data	Body Region	Type of Anatomic Structure	Specific Anatomic Structure	Level of Injury	A.I.S. Severity	Aspect	Injury Source						
1st	5. <u>7</u>	6. <u>6</u>	7. <u>4</u>	8. <u>02</u>	9. <u>78</u>	10. <u>1</u>	11. <u>6</u>	12. <u>997</u>	13. <u>1</u>	14. <u>3</u>	15. <u>0</u>	16. <u>0</u>	17. <u>0</u>	
2nd	18. <u>7</u>	19. <u>7</u>	20. <u>9</u>	21. <u>02</u>	22. <u>02</u>	23. <u>1</u>	24. <u>2</u>	25. <u>947</u>	26. <u>1</u>	27. <u>1</u>	28. <u>0</u>	29. <u>0</u>	30. <u>0</u>	
3rd	31. ___	32. ___	33. ___	34. ___	35. ___	36. ___	37. ___	38. ___	39. ___	40. ___	41. ___	42. ___	43. ___	
4th	44. ___	45. ___	46. ___	47. ___	48. ___	49. ___	50. ___	51. ___	52. ___	53. ___	54. ___	55. ___	56. ___	
5th	57. ___	58. ___	59. ___	60. ___	61. ___	62. ___	63. ___	64. ___	65. ___	66. ___	67. ___	68. ___	69. ___	
6th	70. ___	71. ___	72. ___	73. ___	74. ___	75. ___	76. ___	77. ___	78. ___	79. ___	80. ___	81. ___	82. ___	
7th	83. ___	84. ___	85. ___	86. ___	87. ___	88. ___	89. ___	90. ___	91. ___	92. ___	93. ___	94. ___	95. ___	
8th	96. ___	97. ___	98. ___	99. ___	100. ___	101. ___	102. ___	103. ___	104. ___	105. ___	106. ___	107. ___	108. ___	
9th	109. ___	110. ___	111. ___	112. ___	113. ___	114. ___	115. ___	116. ___	117. ___	118. ___	119. ___	120. ___	121. ___	
10th	122. ___	123. ___	124. ___	125. ___	126. ___	127. ___	128. ___	129. ___	130. ___	131. ___	132. ___	133. ___	134. ___	

OFFICIAL INJURY DATA — SOFT TISSUE INJURIES

Indicate the Location, Specific Anatomic Structure, Detail (size, depth, fracture type, head injury clinical signs and neurological deficits), and Source of all injuries indicated by official sources (or from PAR or other unofficial sources if medical records and interviewee data are unavailable.)

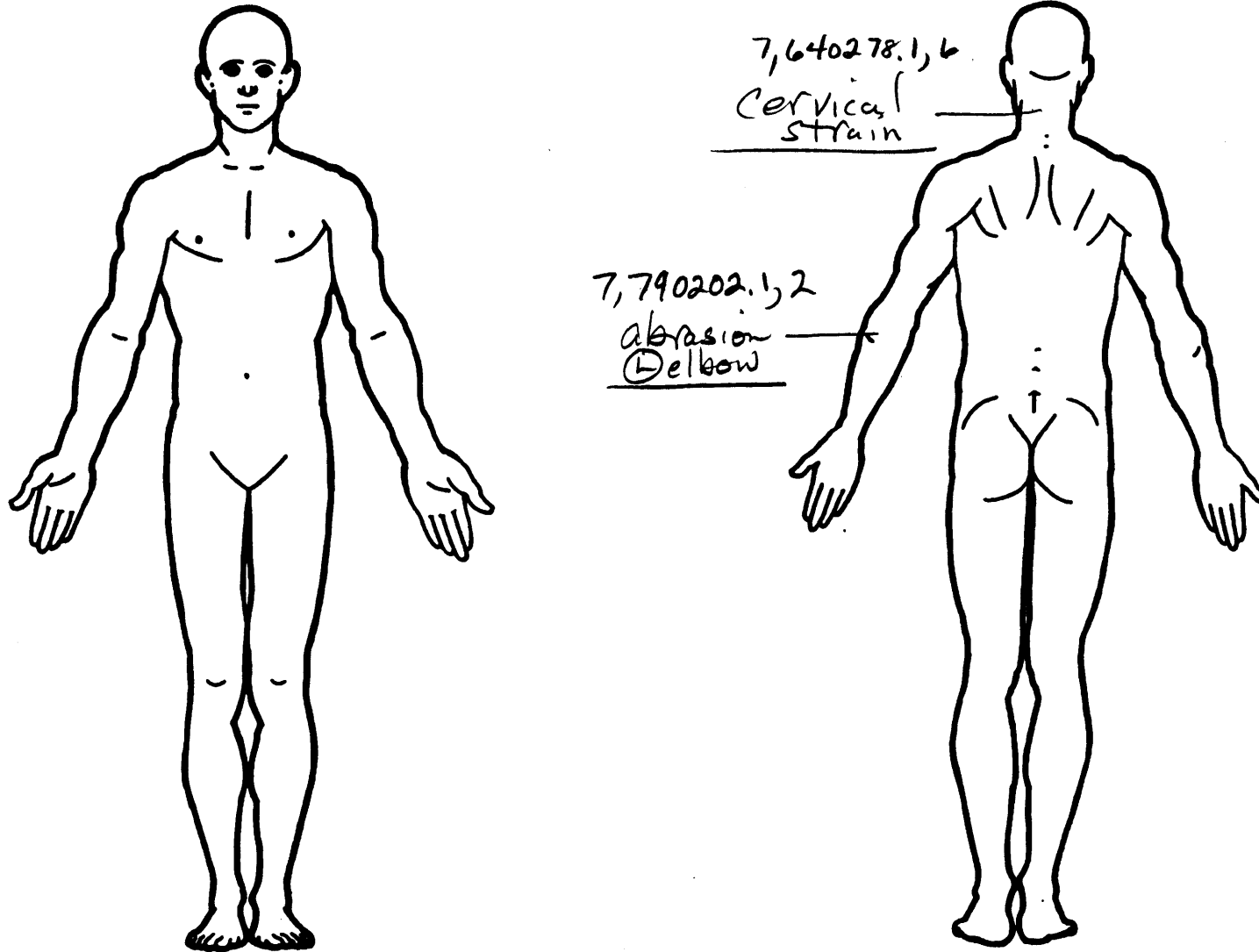

SOURCE OF INJURY DATA**OFFICIAL**

- (1) Autopsy records with or without hospital/medical records
- (2) Hospital/medical records other than emergency room (e.g., discharge summary)
- (3) Emergency room records only (including associated X-rays or other lab reports)
- (4) Private physician, walk-in or emergency clinic

UNOFFICIAL

- (5) Lay coroner report
- (6) E.M.S. personnel
- (7) Interviewee
- (8) Other source (specify): _____
- (9) Police

INJURY SOURCE CONFIDENCE LEVEL

- (1) Certain
- (2) Probable
- (3) Possible
- (9) Unknown

DIRECT/INDIRECT INJURY

- (1) Direct contact injury
- (2) Indirect contact injury
- (3) Noncontact injury
- (7) Injured, unknown source

STRIKING PROFILE

- (0) Injury not from vehicle contact
- (1) Flat-Narrow (< 15 centimeters)
- (2) Flat-Wide (> 15 centimeters)
- (3) Rounded (contoured)
- (4) Rounded edge
- (5) Sharp edge
- (8) Other (specify): _____
- (9) Unknown

TYPE OF DAMAGE

- (0) Injury not from vehicle contact
- (1) No damage/contact
- (2) Scratch (Scuff, Cloth Transfer, Smear)
- (3) Dent
- (4) Large deformation
- (5) Cracked, fractured, shattered
- (6) Separated from vehicle
- (7) Noncontact injury
- (8) Other specify: _____
- (9) Unknown

DAMAGE DEPTH

- (0) Injury not from vehicle contact
- (1) No residual damage
- (2) Surface only damage
- (3) Crush depth > 0 to 2 centimeters
- (4) Crush depth > 2 to 5 centimeters
- (5) Crush depth > 5 to 10 centimeters
- (8) Other specify: _____
- (9) Unknown

PEDESTRIAN INJURY CLASSIFICATION**Body Region**

- (1) Head
- (2) Face
- (3) Neck
- (4) Thorax
- (5) Abdomen
- (6) Spine
- (7) Upper Extremity
- (8) Lower Extremity
- (9) Unspecified

Type of Anatomic Structure

- (1) Whole Area
- (2) Vessels
- (3) Nerves
- (4) Organs (includes muscles/ligaments)
- (5) Skeletal (includes joints)
- (6) Head - LOC
- (9) Skin

Specific Anatomic Structure

- Whole Area
- (02) Skin - Abrasion
 - (04) Skin - Contusion
 - (06) Skin - Laceration
 - (08) Skin - Avulsion
 - (10) Amputation
 - (20) Burn
 - (30) Crush
 - (40) Degloving
 - (50) Injury - NFS
 - (90) Trauma, other than mechanical

Head - LOC

- (02) Length of LOC
- (04, 06, 08) Level of Consciousness
- (10) Concussion

Spine

- (02) Cervical
- (04) Thoracic
- (06) Lumbar

Vessels, Nerves, Organs, Bones, Joints are assigned consecutive two digit numbers beginning with 02

Level of Injury

Specific injuries are assigned consecutive two-digit numbers beginning with 02.

To the extent possible, within the organizational framework of the AIS, 00 is assigned to an injury NFS as to severity or where only one injury is given in the dictionary for that anatomic structure. 99 is assigned to any injury NFS as to lesion or severity.

Abbreviated Injury Scale

- (1) Minor injury
- (2) Moderate injury
- (3) Serious injury
- (4) Severe injury
- (5) Critical injury
- (6) Maximum (untreatable)
- (7) Injured, unknown severity

Aspect

- (1) Right
- (2) Left
- (3) Bilateral
- (4) Central
- (5) Anterior
- (6) Posterior
- (7) Superior
- (8) Inferior
- (9) Unknown
- (0) Whole region

INJURY SOURCEFRONT

- 700 Front bumper
- 701 Front lower valance/spoiler
- 702 Front grille
- 703 Hood edge and/or trim
- 704 Hood ornament (fixed)
- 705 Hood ornament (spring loaded)
- 706 Headlight
- 707 Retractable headlight door (Open/Closed)
- 708 Turn signal/parking lights
- 718 Other front or add on object (specify): _____
- 719 Unknown front object

Left Side Components

- 720 Front fender side surface
- 721 Front antenna
- 722 A1 pillar
- 723 A2 pillar
- 724 B pillar
- 725 C pillar
- 726 D pillar
- 728 Other pillar (specify): _____
- 729 Left side roof rail
- 730 Left side door surface
- 731 Left side door handle
- 732 Left side mirror fixed housing
- 733 Left side folding mirror
- 734 Left side glazing forward of B pillar
- 735 Left side glazing rearward of B pillar
- 736 Left side back fender or quarter panel
- 737 Rear antenna
- 738 Other left side object (specify): _____
- 739 Unknown left side component

Right Side Components

- 740 Front fender side surface
- 741 Front antenna
- 742 A1 pillar
- 743 A2 pillar

- 744 B pillar
- 745 C pillar
- 746 D pillar
- 748 Other pillar (specify): _____
- 749 Right side roof rail
- 750 Right side door surface
- 751 Right side door handle
- 752 Right side mirror fixed housing
- 753 Right side folding mirror
- 754 Right side glazing forward of B pillar
- 755 Right side glazing rearward of B pillar
- 756 Rear antenna
- 757 Rear fender or quarter panel
- 758 Other right side object (specify): _____
- 759 Unknown right side component

Back Components

- 760 Rear (back) bumper
- 761 Tailgate
- 762 Hatchback, vertical surface
- 768 Other back component (specify): _____
- 769 Unknown back component

Top Components

- 770 Hood surface
- 771 Hood surface reinforced by under hood component
- 772 Front fender top surface
- 773 Cowl area
- 774 Wiper blade & mountings
- 775 Windshield glazing
- 776 Front header
- 777 Roof surface
- 778 Backlight glazing
- 779 Rear header
- 780 Hatchback
- 781 Rear trunk lid
- 788 Other top component (specify): _____
- 789 Unknown top component

Wheels / tires

- 790 Left front wheel / tire
- 791 Right front wheel / tire
- 792 Left rear wheel / tire
- 793 Right rear wheel / tire
- 798 Other wheel / tire (specify): _____
- 799 Unknown wheel / tire

Undercarriage components

- 800 Front crossmember
- 801 Steering assembly/Front suspension
- 802 Oil pan
- 803 Exhaust system pipe
- 804 Transmission
- 805 Drive shaft
- 806 Catalytic converter
- 807 Muffler
- 808 Floor pan
- 809 Fuel tank
- 810 Rear suspension
- 818 Other undercarriage component (specify): _____
- 819 Unknown undercarriage component

Accessories

- 820 Air scoop, deflector
- 821 Cellular or CB radio antenna
- 822 Emergency lights or bar
- 823 Fog lights
- 824 Luggage, ski, or bike rack
- 825 Cargo (specify): _____
- 826 Spare tire
- 827 Spotlight
- 828 Other accessory (specify): _____

Other Object or Vehicle in Environment

- 947 Ground
- 948 Other object (specify): _____
- 949 Unknown object in environment
- 959 Unknown object on contacting vehicle
- 997 Noncontact injury source
- 999 Unknown injury source

OFFICIAL INJURY DATA — SKELETAL INJURIES

Restrained?

No

Indicate the Location, Specific Anatomic Structure, Detail (size, depth, fracture type, head injury clinical signs and neurological deficits), and Source of all injuries indicated by official sources (or from PAR or other unofficial sources if medical records and interviewee data are unavailable.)

Yes

Blood Alcohol Level
(mg/dl)

BAL = ?

Glasgow Coma
Scale Score

GCSS = 02

Units of Blood
Given

Units = 1

Arterial Blood Gases

Ph = /

PO₂ = /

PCO₂ = /

HCO₃ = /

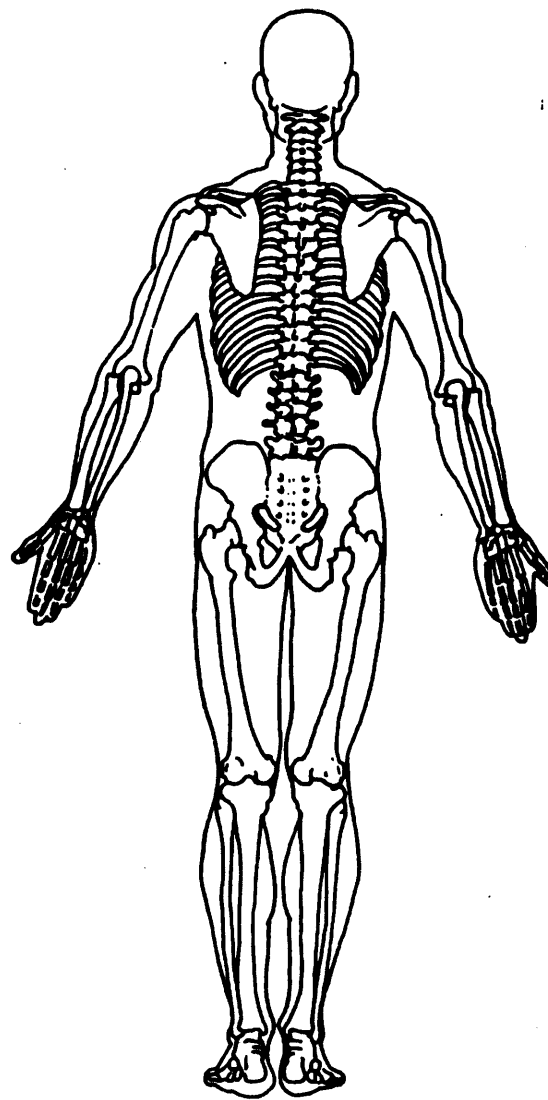
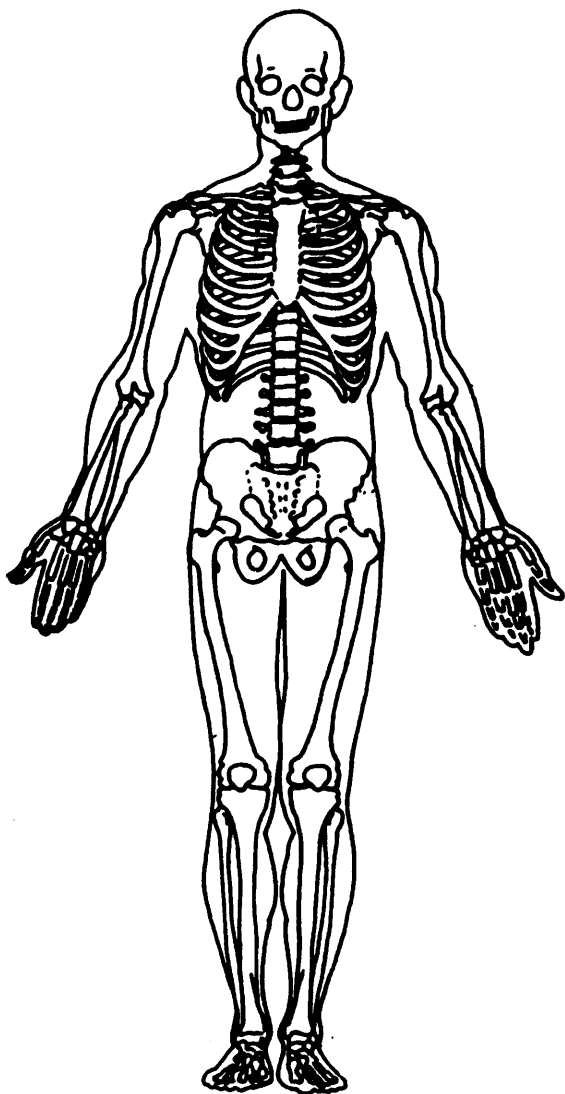

OFFICIAL INJURY DATA — INTERNAL INJURIES

Indicate the Location, Specific Anatomic Structure, Detail (size, depth, fracture type, head injury clinical signs and neurological deficits), and Source of all injuries indicated by official sources (or from PAR or other unofficial sources if medical records and interviewee data are unavailable.)

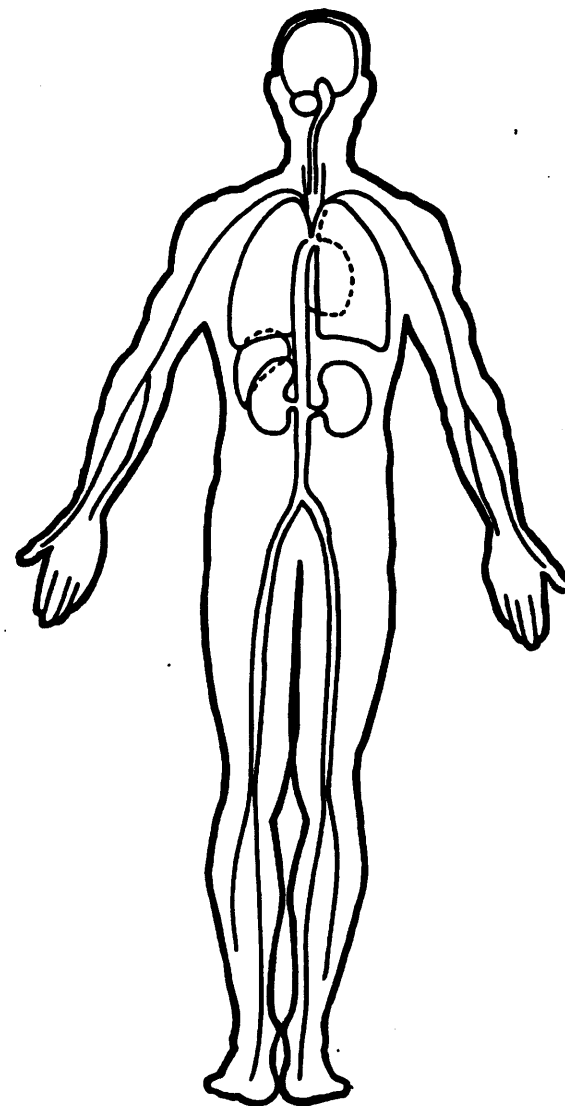
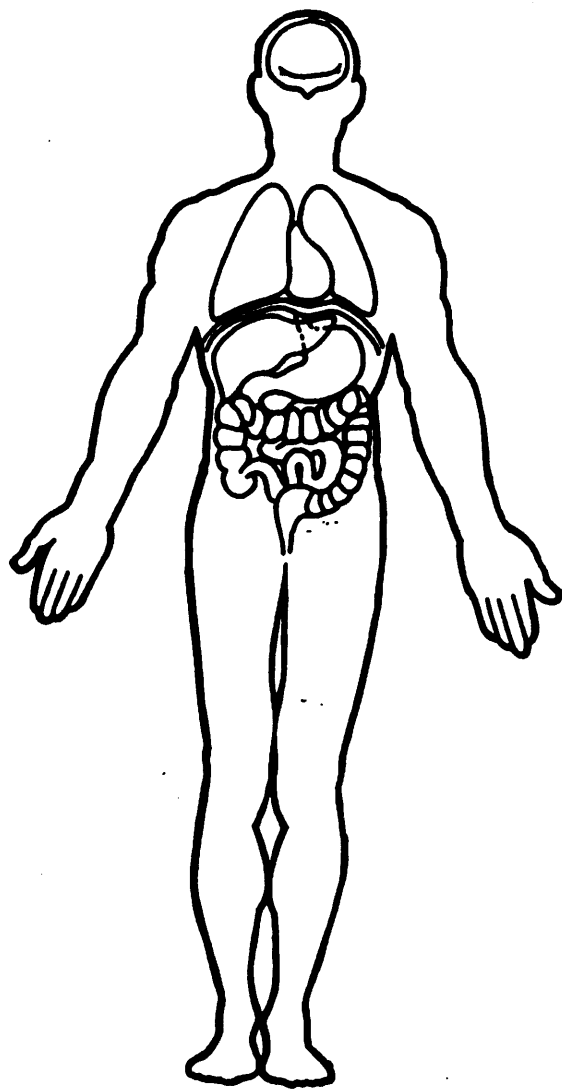



1. Primary Sampling Unit Number 82
 2. Case Number - Stratum 601 P
 3. Vehicle Number 01

VEHICLE IDENTIFICATION

4. Vehicle Model Year 92
 Code the last two digits of the model year
 (99) Unknown

5. Vehicle Make (specify): 49
Toyota
 Applicable codes are found in your
 NASS PCDS Data Collection, Coding and
 Editing Manual.
 (99) Unknown

6. Vehicle Model (specify): 042
Paseo
 Applicable codes are found in your
 NASS PCDS Data Collection, Coding and
 Editing Manual.
 (99) Unknown

7. Body Type 02
 Note: Applicable codes may be found on
 the back of this page.

8. Vehicle Identification Number
JT2EL45FIN 
 1 2 3 4 5 6 7 8 9 10 11 12 13 14 15 16 17

Left justify; Slash zeros and letter Z (0 and Z)
 No VIN—Code all zeros
 Unknown—Code all nines

OFFICIAL RECORDS

9. Police Reported Travel Speed 999
 Code to the nearest kmph (NOTE: 000 means
 less than 0.5 kmph)
 (160) 159.5 kmph and above
 (999) Unknown
 ___ mph X 1.6093 = ___ kmph

10. Speed Limit 048
 (000) No statutory limit
 Code posted or statutory speed limit
 in kmph
 (999) Unknown
30 mph X 1.6093 = ___ kmph

11. Police Reported Alcohol Presence For Driver 0
 (0) No alcohol present
 (1) Yes alcohol present
 (7) Not reported
 (8) No driver present
 (9) Unknown

12. Alcohol Test Result For Driver 96
 Code actual value (decimal implied
 before first digit—0.xx)
 (95) Test refused
 (96) None given
 (97) AC (Alcohol Content) test
 performed, results unknown
 (98) No driver present
 (99) Unknown
 Source: PHR

13. Police Reported Other Drug Presence
 For Driver 0
 (0) No other drug(s) present
 (1) Yes other drug(s) present
 (7) Not reported
 (8) No driver present
 (9) Unknown

14. Other Drug Specimen Test Result
 For Driver 0
 (0) No specimen test given
 (1) Drug not found in specimen
 (2) Drug found in specimen
 (specify): _____
 (3) Specimen test given, results
 unknown or not obtained
 (8) No driver present
 (9) Unknown

CODES FOR BODY TYPE

CDS APPLICABLE VEHICLES

Automobiles

- (01) Convertible (excludes sun-roof, t-bar)
- (02) 2-door sedan, hardtop, coupe
- (03) 3-door/2-door hatchback
- (04) 4-door sedan, hardtop
- (05) 5-door/4-door hatchback
- (06) Station wagon (excluding van and truck based)
- (07) Hatchback, number of doors unknown
- (08) Other automobile type (specify): _____
- (09) Unknown automobile type

Automobile Derivatives

- (10) Auto based pickup (includes El Camino, Caballero, Ranchero, Brat, and Rabbit pickup)
- (11) Auto based panel (cargo station wagon, auto based ambulance/hearse)
- (12) Large limousine - more than four side doors or stretched chassis
- (13) Three-wheel automobile or automobile derivative

Utility Vehicles ($\leq 4,500$ kgs GVWR)

- (14) Compact utility (Jeep CJ-2 - CJ-7, Scrambler, Golden Eagle, Renegade, Laredo, Wrangler, Cherokee [84 and after], Dispatcher, Raider, Bronco II, Bronco [76 and before], Explorer, S-10 Blazer, Geo Tracker, Bravada, S-15 Jimmy, Thing, Pathfinder, Trooper, Trooper II, Rodeo, Amigo, Navajo, 4-Runner, Montero, Samurai, Sidekick, Rocky)
- (15) Large utility (includes Jeep Cherokee [83 and before], Ramcharger, Trailduster, Bronco-fullsize [78 and after], fullsize Blazer, fullsize Jimmy, Landcruiser, Rover, Scout)
- (16) Utility station wagon (Chevy Suburban, GMC Suburban, Travelall, Grand Wagoneer, includes suburban limousine)
- (19) Utility, unknown body type

Van Based Light Trucks ($\leq 4,500$ kgs GVWR)

- (20) Minivan (Chrysler Town and Country, Caravan, Grand Caravan, Voyager, Grand Voyager, Mini-Ram, Dodge/Plymouth Vista, Aerostar, Villager, Lumina APV, Trans Sport, Silhouette, Astro, Safari, Toyota Van, Toyota Minivan, Previa, Nissan Minivan, Quest, Mitsubishi Minivan, Vanagon/Camper.)
- (21) Large van (B150-B350, Sportsman, Royal, Maxiwagon, Ram, Tradesman, Voyager [83 and before], E150-E350, Econoline, Clubwagon, Chateau, G10-G30, Chevy Van, Beauville, Sport Van, G15-G35, Rally Van, Vandura.)
- (22) Step van or walk-in van ($\leq 4,500$ kgs GVWR)
- (23) Van based motorhome ($\leq 4,500$ kgs GVWR)
- (24) Van based school bus ($\leq 4,500$ kgs GVWR)
- (25) Van based other bus ($\leq 4,500$ kgs GVWR)
- (28) Other van type (Hi-Cube Van, Kary) (specify): _____
- (29) Unknown van type

Light Conventional Trucks (Pickup style cab, $\leq 4,500$ kgs GVWR)

- (30) Compact pickup (D50, Colt P/U, Ram 50, Dakota, Arrow Pickup [foreign], Ranger, Courier, S-10, T-10, LUV, S-15, T-15, Sonoma, Datsun/Nissan Pickup, P'up, Mazda Pickup, Toyota Pickup, Mitsubishi Pickup)
- (31) Large Pickup (Jeep Pickup, Comanche, Ram Pickup, D100-D350, W100-W350, F100-F350, C10-C35, K10-K35, R10-R35, V10-V35, Silverado, Sierra, R100-R500.)

- (32) Pickup with slide-in camper
- (33) Convertible pickup
- (39) Unknown pickup style light conventional truck type

Other Light Trucks ($\leq 4,500$ kgs GVWR)

- (40) Cab chassis based (includes rescue vehicles, light stake, dump, and tow truck)
- (41) Truck based panel
- (42) Light truck based motorhome (chassis mounted)
- (45) Other light conventional truck type
- (48) Unknown light truck type
- (49) Unknown light vehicle type (automobile, utility, van, or light truck)

OTHER VEHICLES

Buses (Excludes Van Based)

- (50) School bus (designed to carry students, not cross country or transit)
- (58) Other bus type (e.g., transit, intercity, bus based motorhome) (specify): _____
- (59) Unknown bus type

Medium/Heavy Trucks ($> 4,500$ kgs GVWR)

- (60) Step van ($> 4,500$ kgs GVWR)
- (61) Single unit straight truck (4,500 kgs $<$ GVWR \leq 8,850 kgs)
- (62) Single unit straight truck (8,850 kgs $<$ GVWR \leq 12,000 kgs)
- (63) Single unit straight truck ($>$ 12,000 kgs GVWR)
- (64) Single unit straight truck, GVWR unknown
- (65) Medium/heavy truck based motorhome
- (67) Truck-tractor with no cargo trailer
- (68) Truck-tractor pulling one trailer
- (69) Truck-tractor pulling two or more trailers
- (70) Truck-tractor (unknown if pulling trailer)
- (78) Unknown medium/heavy truck type
- (79) Unknown truck type (light/medium/heavy)

Motored Cycles (Does Not Include All-Terrain Vehicles/Cycles)

- (80) Motorcycle
- (81) Moped (motorized bicycle)
- (82) Three-wheel motorcycle or moped
- (88) Other motored cycle (minibike, motorscooter) (specify): _____
- (89) Unknown motored cycle type

Other Vehicles

- (90) ATV (All-Terrain Vehicle) and ATC (All-Terrain Cycle)
- (91) Snowmobile
- (92) Farm equipment other than trucks
- (93) Construction equipment other than trucks
- (97) Other vehicle type
- (99) Unknown body type

VEHICLE WEIGHT ITEMS

15. Vehicle Curb Weight

Code weight to nearest
10 kilograms.

- (045) Less than 450 kilograms
(610) 6,100 kilograms or more
(999) Unknown

2070 lbs X .4536 = 939 kgs

Source: [REDACTED]

16. Vehicle Cargo Weight

Code weight to nearest
10 kilograms.

- (000) Less than 5 kilograms
(450) 4,500 kilograms or more
(999) Unknown

_____ lbs X .4536 = _____ kgs

OTHER DATA

17. Vehicle Special Use (This Trip)

- (0) No special use
(1) Taxi
(2) Vehicle used as school bus
(3) Vehicle used as other bus
(4) Military
(5) Police
(6) Ambulance
(7) Fire truck or car
(8) Other (specify): _____
(9) Unknown

STOP - VARIABLES 18 THROUGH 20

ARE COMPLETED BY THE ZONE CENTER

RECONSTRUCTION DATA

18. Impact Speed

Nearest kmph

- (NOTE: 000 means greater than .5 kmph)
(160) 159.5 kmph and above
(999) Unknown

19. Accuracy Range of Impact Speed Estimate

- (0) No reconstruction
(1) Less than 2 kmph
(2) ≥ 2 kmph and ≤ 8 kmph
(3) ≥ 9 kmph and ≤ 16 kmph
(4) ≥ 17 kmph and ≤ 26 kmph
(9) Unknown

20. Data Source of Impact Speed

- (0) No impact speed calculated
(1) Zone center calculation
(2) Police calculation
(3) Driver/witness/police estimates

PRECRASH DATA

21. Driver's Attention to Driving

(Prior to Recognition of Critical Event)

- (1) Full attention to driving
(2) Distracted by other occupant
(3) Distracted by moving object in vehicle
(4) Distracted by outside person, object, or event
(5) Talking on cellular phone or CB radio
Specify: Sun in her eyes
(6) Sleeping or dozing while driving
(8) Other (specify): _____
(9) Unknown

22. Pre-Event Vehicle Movement

(Prior to Recognition of Critical Event)

- (01) Going straight
(02) Slowing or stopping in traffic lane
(03) Starting in traffic lane
(04) Stopped in traffic lane
(05) Passing or overtaking another vehicle
(06) Disabled or parked in travel lane
(07) Leaving a parking position
(08) Entering a parking position
(09) Turning right
(10) Turning left
(11) Making a U-turn
(12) Backing up (other than for parking position)
(13) Negotiating a curve
(14) Changing lanes
(15) Merging
(16) Successful avoidance maneuver to a previous critical event
(97) Other (specify): _____
(98) No driver present
(99) Unknown

23. Critical Precrash Event

This Vehicle Loss of Control Due To:

- (01) Blow out or flat tire
 (02) Stalled engine
 (03) Disabling vehicle failure (e.g., wheel fell off)
 (specify): _____
 (04) Non-disabling vehicle problem (e.g., hood flew up)
 (specify): _____
 (05) Poor road conditions (puddle, pot hole, ice, etc.)
 (specify): _____
 (06) Traveling too fast for conditions
 (08) Other cause of control loss (specify): _____

(09) Unknown cause of control loss

This Vehicle Traveling

- (10) Over the lane line on left side of travel lane
 (11) Over the lane line on right side of travel lane
 (12) Off the edge of the road on the left side
 (13) Off the edge of the road on the right side
 (14) End departure
 (15) Turning left at intersection
 (16) Turning right at intersection
 (17) Crossing over (passing through) intersection
 (19) Unknown travel direction

Other Motor Vehicle In Lane

- (50) Stopped
 (51) Traveling in same direction with lower speed
 (i.e., lower steady speed or decelerating)
 (52) Traveling in same direction with higher speed
 (53) Traveling in opposite direction
 (54) In crossover
 (55) Backing
 (59) Unknown travel direction of other motor vehicle
 in lane

Other Motor Vehicle Encroaching Into Lane

- (60) From adjacent lane (same direction)—over left
 lane line
 (61) From adjacent lane (same direction)—over right
 lane line
 (62) From opposite direction—over left lane line
 (63) From opposite direction—over right lane line
 (64) From parking lane
 (65) From crossing street, turning into same direction
 (66) From crossing street, across path
 (67) From crossing street, turning into opposite
 direction
 (68) From crossing street, intended path not known
 (70) From driveway, turning into same direction
 (71) From driveway, across path
 (72) From driveway, turning into opposite direction
 (73) From driveway, intended path not known
 (74) From entrance to limited access highway
 (78) Encroachment by other vehicle—details
 unknown

Pedestrian or Pedalcyclist, or Other Nonmotorist

- (80) Pedestrian in roadway
 (81) Pedestrian approaching roadway
 (82) Pedestrian—unknown location

(83) Pedalcyclist or other nonmotorist in roadway
 (specify): _____

(84) Pedalcyclist or other nonmotorist approaching
 roadway (specify): _____

(85) Pedalcyclist or other nonmotorist—unknown
 location (specify): _____

Object or Animal

- (87) Animal in roadway
 (88) Animal approaching roadway
 (89) Animal—unknown location
 (90) Object in roadway
 (91) Object approaching roadway
 (92) Object—unknown location
 (98) Other critical precrash event (specify): _____

(99) Unknown

24. Attempted Avoidance Maneuver

- (00) No driver present
 (01) No avoidance actions
 (02) Braking (no lockup)
 (03) Braking (lockup)
 (04) Braking (lockup unknown)
 (05) Releasing brakes
 (06) Steering left
 (07) Steering right
 (08) Braking and steering left
 (09) Braking and steering right
 (10) Accelerating
 (11) Accelerating and steering left
 (12) Accelerating and steering right
 (98) Other action (specify): _____
 (99) Unknown

25. Precrash Stability After Avoidance Maneuver

- (0) No driver present
 (1) No avoidance maneuver
 (2) Tracking
 (3) Skidding longitudinally—rotation less than 30
 degrees
 (4) Skidding laterally—clockwise rotation
 (5) Skidding laterally—counterclockwise rotation
 (8) Other vehicle loss-of-control (specify): _____
 (9) Precrash stability unknown

26. Precrash Directional Consequences of
Avoidance Maneuver (Corrective Action)

- (0) No driver present
 (1) No avoidance maneuver
 (2) Vehicle stayed in travel lane where avoidance
 maneuver was initiated
 (3) Vehicle stayed on roadway but left travel lane
 where avoidance maneuver was initiated
 (4) Vehicle stayed on roadway, not known if left
 travel lane where avoidance maneuver was
 initiated
 (5) Vehicle departed roadway
 (6) Avoidance maneuver initiated off roadway
 (9) Directional consequences unknown

15

01

poor
 impact
 Braking

1

1

ENVIRONMENTAL DATA

27. Relation to Junction 3 ✓

- (0) Non-junction
- (1) Interchange area

Non-Interchange

- (2) Intersection
- (3) Intersection-related
- (4) Drive, alley access related
- (5) Other non-interchange (specify): _____
- (6) _____
- (9) Unknown type of non-interchange

28. Trafficway Flow 1 ✓

- (1) Not physically divided (two way traffic)
- (2) Divided trafficway - median strip without positive barrier
- (3) Divided trafficway - median strip with positive barrier
- (4) One way trafficway
- (9) Unknown

29. Number of Travel Lanes 4 ✓

- (1) One
- (2) Two
- (3) Three
- (4) Four
- (5) Five
- (6) Six
- (7) Seven or more
- (9) Unknown

30. Roadway Alignment 1 ✓

- (1) Straight
- (2) Curve right
- (3) Curve left
- (9) Unknown

31. Roadway Profile 3 ✓

- (1) Level
- (2) Uphill Grade (> 2%) -1/122
- (3) Downhill Grade (> 2%)
- (4) Hillcrest
- (5) Sag
- (9) Unknown

32. Roadway Surface Type 12 ✓

- (1) Concrete
- (2) Bituminous (asphalt)
- (3) Brick or Block
- (4) Slag, gravel or stone
- (5) Dirt
- (8) Other (specify): _____
- (9) Unknown

33. Roadway Surface Condition 7 ✓

- (1) Dry
- (2) Wet
- (3) Snow and slush
- (4) Ice
- (5) Sand, dirt or oil
- (8) Other (specify): _____
- (9) Unknown

34. Traffic Control Device 1 ✓

- (0) No traffic control(s)
- (1) Trafficway traffic control signal (not RR crossing)

Regulatory or School Zone Sign (Not RR Crossing)

- (2) Stop sign
- (3) Yield sign
- (4) School zone sign
- (5) Other sign (specify): _____
- (6) _____
- (7) Warning sign (not RR crossing)
- (8) Miscellaneous/other controls including RR controls (specify): _____
- (9) Unknown

35. Traffic Control Device Functioning 2 ✓

- (0) No traffic control
- (1) Not Functioning
- (2) Functioning
- (9) Unknown

36. Light Conditions 1 ✓

- (1) Daylight
- (2) Dark
- (3) Dark, but lighted
- (4) Dawn
- (5) Dusk
- (9) Unknown

37. Atmospheric Conditions 1 ✓

- (1) No adverse atmospheric related driving conditions
- (2) Rain
- (3) Sleet
- (4) Snow
- (5) Fog
- (6) Rain and fog
- (7) Sleet and fog
- (8) Other (e.g., smog, smoke, blowing sand or dust, etc.) (specify): _____
- (9) Unknown

2. phase of sun.

82-601P

1996

92 Toyota Paseo

1340F

147C

58"

New Sun Car.

FRP to POI

right elbow

$$4m = 13ft$$

reaction time 1.5s-c

$$S = Vt + \frac{V^2}{2 + g}$$

$$13 = 1.5V + \frac{V^2}{(2)(0.65)(32.2)} \quad 0.024V^2$$

$$0.024V^2 + 1.5V - 13 = 0$$

$$A = 0.024$$

$$B = 1.5$$

$$C = -13$$

$$V = \frac{-b \pm \sqrt{b^2 - 4AC}}{2A}$$

$$V = \frac{-1.5 \pm \sqrt{2.25 + 1.24}}{2A}$$

$$V = \frac{-1.5 \pm \sqrt{3.49}}{2A}$$

$$= \frac{0.368}{2A} = \frac{0.368}{0.048} =$$

$$= 7.7 \text{ fps} = 5 \text{ mph} = 8 \text{ kph}$$



1. Primary Sampling Unit Number	<u>82</u>	3. Vehicle Number	<u>01</u>
2. Case Number - Stratum	<u>601 P</u>		

VEHICLE IDENTIFICATION

VIN JT2FL4SK1N [REDACTED] Model Year 92

Vehicle Make (specify): Toyota Vehicle Model (specify): Passo

PEDESTRIAN FRONT CONTACT WORK SHEET

PEV06 Hood Material	<u>Steel</u>
PEV08 Hood Length	<u>099</u> cm ✓
PEV09 Hood Width-Forward Opening	<u>125</u> cm ✓
PEV10 Hood Width-Midway	<u>130</u> cm ✓
PEV11 Hood Width-Rear Opening	<u>132</u> cm ✓
PEV14 Front Bumper Cover Material	<u>Rubber</u>
PEV15 Front Bumper Reinforcement Material	<u>Steel</u>

VERTICAL MEASUREMENTS

PEV16 Front Bumper-Bottom Height	<u>031</u> cm ✓
PEV17 Front Bumper-Top Height	<u>051</u> cm ✓
PEV18 Forward Hood Opening	<u>057</u> cm ✓
PEV19 Front Bumper Lead	<u>009</u> cm ✓

WRAP DISTANCES

PEV20 Ground to Forward Hood Opening	<u>064</u> cm ✓
PEV21 Ground to Front/Top Transition Point	<u>066</u> cm ✓
PEV22 Ground to Rear Hood Opening	<u>170</u> cm ✓
PEV23 Ground to Base of Windshield	<u>178</u> cm ✓
PEV24 Ground to Top of Windshield	<u>254</u> cm ✓
PEV25 Ground to Head Contact	<u>NONE</u> cm

VEHICLE DAMAGE SKETCH

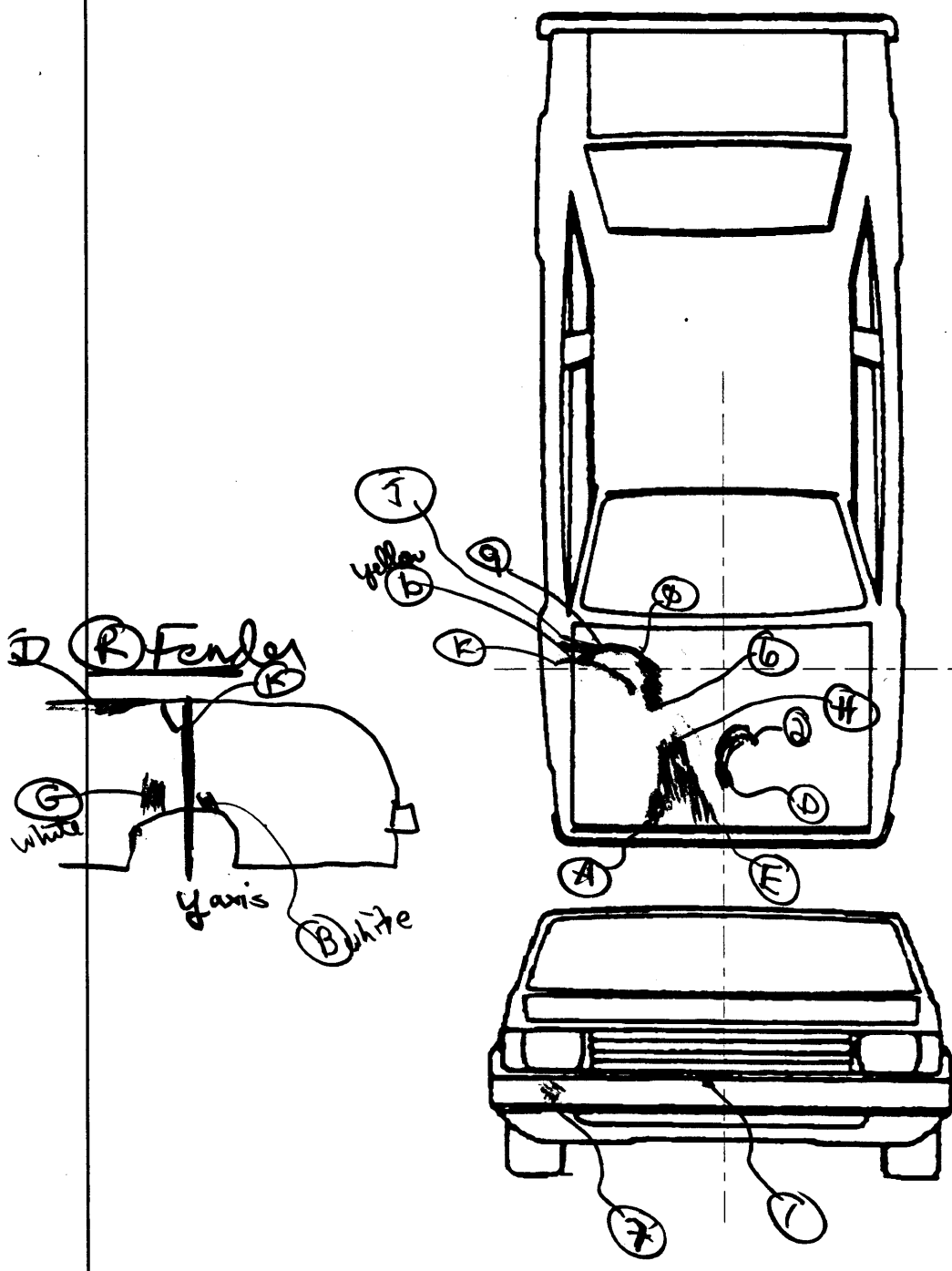

NOTES: Sketch all pedestrian contacts, include the size and depth in centimeters. Locate the pedestrian contacts from the intercept point of the centerline (lateral) and the front axles (longitudinal) in centimeters. Annotate observations which might be useful in reconstructing the accident (e.g., grass in tire bead, direction of striations, scuff on sidewalls, etc.).

Location of the origin (intercept point of the centerline and the front axles) from the ground: 152 cm

VIN JT2EL45FIN XXXXXXXXXX

Model Year 92

Vehicle Make (specify): Toyota

Vehicle Model (specify): Paseo 2 Dr

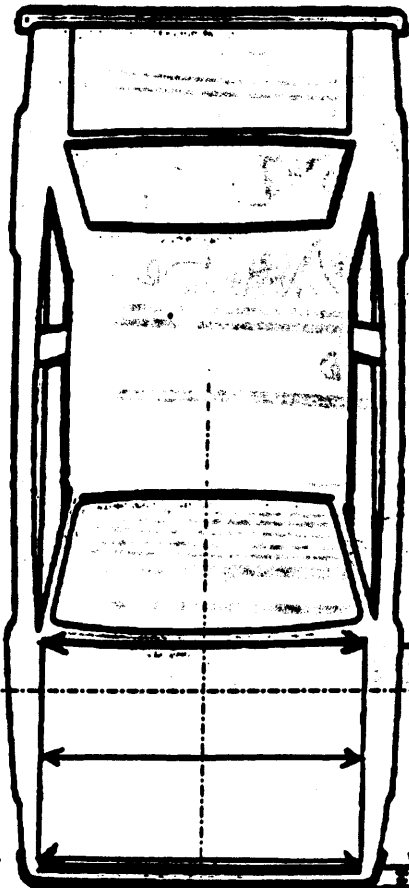

Hood Material
Steel

Front Bumper Cover Material
Rubber

Front Bumper Reinforcement Material
Steel

Hood Widths
Rear Opening 132
Midway 130
Forward Opening 125

99 Hood Length
9 Bumper Lead

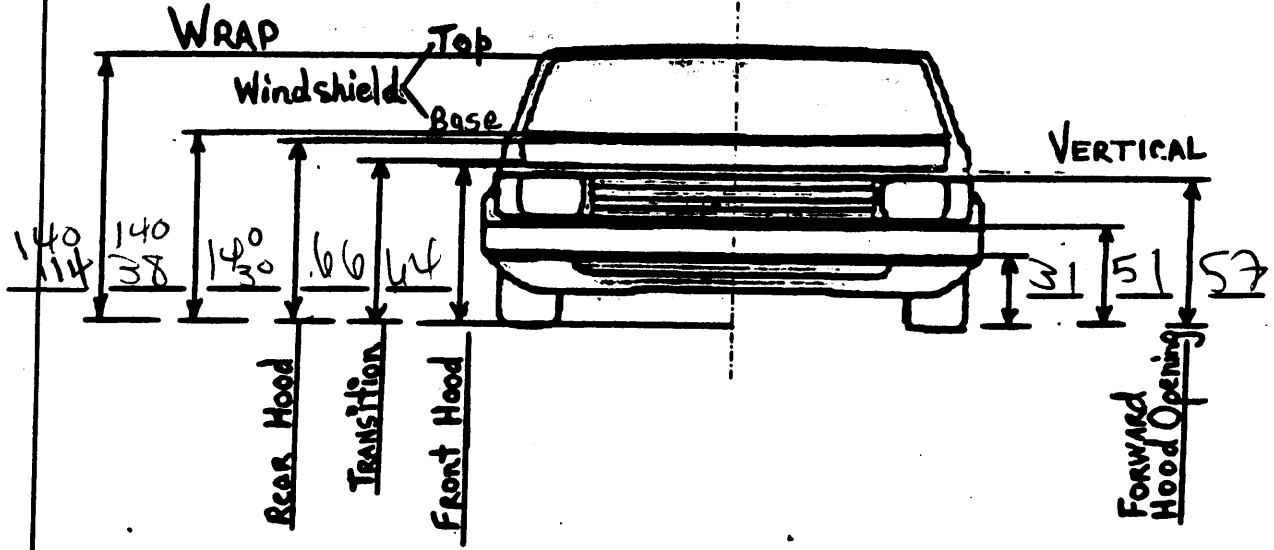

NOTES: Sketch all pedestrian contacts, include the size and depth in centimeters. Locate the pedestrian contacts from the intercept point of the centerline (lateral) and the front edge (longitudinal) in centimeters. Annotate observations which might be useful in reconstructing the accident (e.g., grass in the back, direction of contact, stuff on sidewalk, etc.).

Location of the origin (intercept point of the centerline and the front edge) from the ground: 140
12 cm

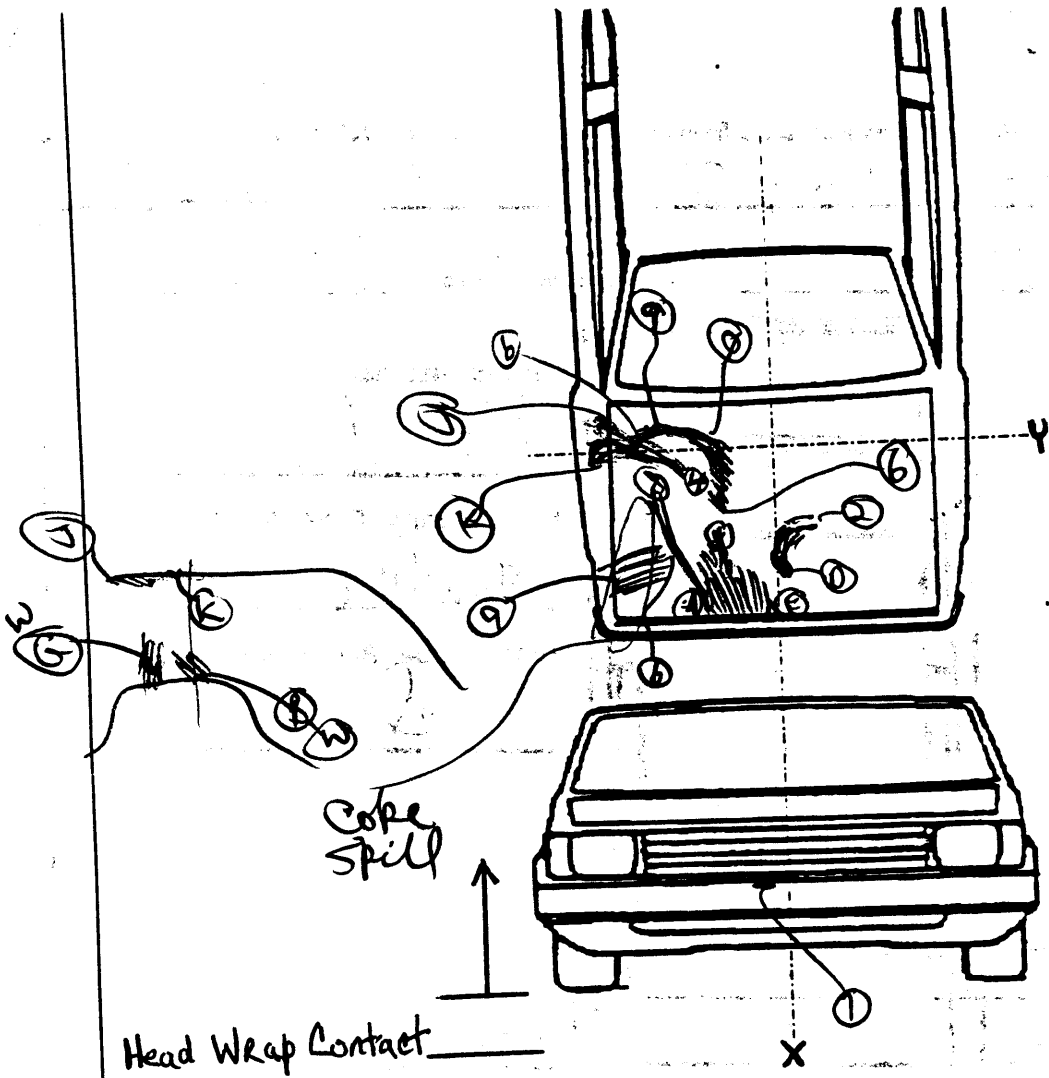

NOTES: Sketch all pedestrian contacts, include the size and depth in centimeters. Locate the pedestrian contacts from the intercept point of the centerline (lateral) and the front axes (longitudinal) in centimeters. Annotate observations which might be useful in reconstructing the accident (e.g., grass in tire bead, direction of striations, scuff on sidewalks, etc.).

Location of the origin (intercept point of the centerline and the front axes) from the ground: _____ cm

POINTS OF PEDESTRIAN CONTACT -- PEDESTRIAN # 1

PEDESTRIAN CONTACT WORKSHEET PAGE

CONTACT ID LABEL	COMPONENT CONTACTED (CODE or OBJECT)	LONGITUDINAL LOCATION	LATERAL LOCATION	CRUSH IN CM	SUSPECTED BODY REGION	SUPPORTING PHYSICAL EVIDENCE	CONFIDENCE LEVEL OF CONTACT POINT
1	Bumper	I-57	5		Legs		1 2 3 9
2	Bump	I-49	51		Legs		1 2 3 9
3	Hood Edge	I-66	0		Legs/Arm		1 2 3 9
4	Hood	I-75	31		Legs/Arm		1 2 3 9
5	Hood	47	22				1 2 3 9
6	Hood	60	-2		Trailing Foot		1 2 3 9
7	"	25	-17				1 2 3 9
8	Hood	27	25		Back Pack		1 2 3 9
9	Hood	17	22		Back Pack		1 2 3 9
10	Hood	14	52		Hand Bag		1 2 3 9
11	Hood	16	50				1 2 3 9
12	Hood	12	40		Like Can in Hand		1 2 3 9
13	Hood	16	61				1 2 3 9
14	Top Fender	0	75				1 2 3 9
15	Fender	-17	70				1 2 3 9
16	Fender	-18	87				1 2 3 9
17		5	92				1 2 3 9
18	Hood	39	39		Side of Legs		1 2 3 9
19	Hood	50	64				1 2 3 9
							1 2 3 9
							1 2 3 9
							1 2 3 9
							1 2 3 9
							1 2 3 9
							1 2 3 9

5
6
7
8
9
10
11
12
13
14
15
16
17
18
19

Scratch

PEDESTRIAN SIDE CONTACT WORK SHEET

PEV06 Hood Material	_____	
PEV08 Hood Length	_____	cm
PEV09 Hood Width-Forward Opening	_____	cm
PEV10 Hood Width-Midway	_____	cm
PEV11 Hood Width-Rear Opening	_____	cm

VERTICAL MEASUREMENTS

PEV26 Ground Clearance	_____	cm
PEV27 Side Bumper-Bottom Height	_____	cm
PEV28 Side Bumper-Top Height	_____	cm
PEV29 Centerline of Wheel	_____	cm
PEV30 Top of Tire	_____	cm
PEV31 Top of Wheel Well Opening	_____	cm
PEV32 Bottom of A-Pillar at Windshield	_____	cm
PEV33 Top of A-Pillar at Windshield	_____	cm
PEV34 Top of Side View Mirror	_____	cm

LATERAL MEASUREMENTS

PEV35 C _L to A-Pillar at Bottom of Windshield	_____	cm
PEV36 C _L to A-Pillar at Top of Windshield	_____	cm
PEV37 C _L to Maximum Side View Mirror Protrusion	_____	cm

WRAP DISTANCES

PEV38 Ground to Side/Top Transition	_____	cm
PEV39 Ground to Hood Edge	_____	cm
PEV40 Ground to Centerline of Hood (ORIGIN)	_____	cm
PEV41 Ground to Head Contact	_____	cm

VEHICLE DAMAGE SKETCH

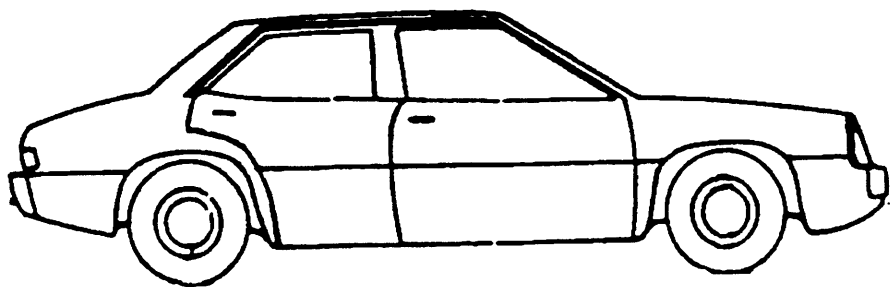
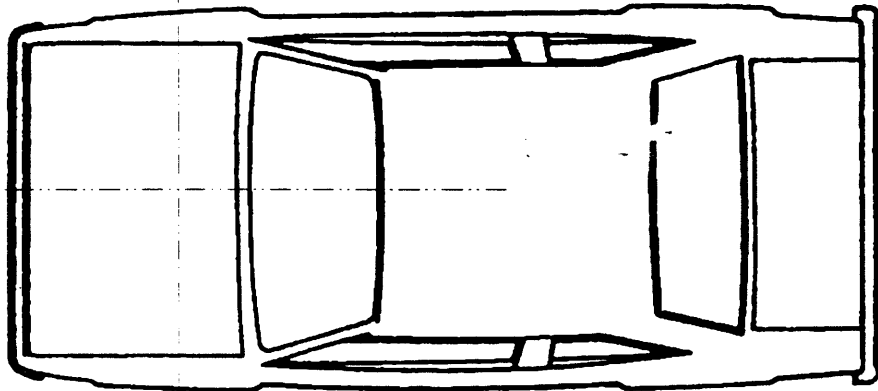
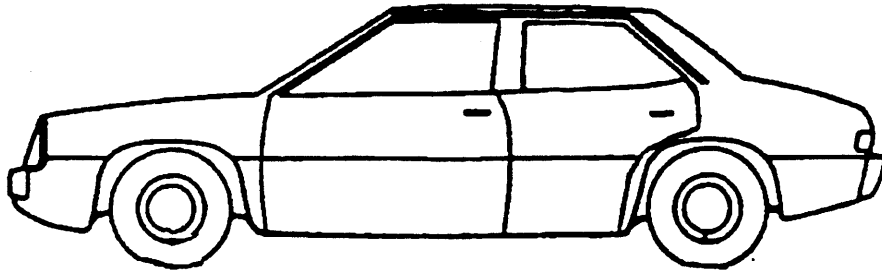

NOTES: Sketch all pedestrian contacts, include the size and depth in centimeters. Locate the pedestrian contacts from the intercept point of the centerline (lateral) and the front axes (longitudinal) in centimeters. Annotate observations which might be useful in reconstructing the accident (e.g., grass in tire bead, direction of striations, scuff on sidewalls, etc.).

Location of the origin (intercept point of the centerline and the front axes) from the ground: _____ cm

ORIGINAL SPECIFICATIONS

Wheelbase	93.7	inches	x	2.54	=	238	cm ✓
Overall Length	163.2	inches	x	2.54	=	415	cm ✓
Maximum Width	65.2	inches	x	2.54	=	166	cm ✓
Curb Weight	2070	pounds	x	.4536	=	939	kg ✓
Average Track	55.1	inches	x	2.54	=	140	cm ✓
Front Overhang	---	inches	x	2.54	=	---	cm
Rear Overhang	---	inches	x	2.54	=	---	cm
Undeformed End Width	---	inches	x	2.54	=	---	cm
Engine Size: cyl./displ.	---	cc	x	.001	=	3515	L
	---	CID	x	.0164	=	L4	L

INJURY SOURCE

FRONT

- 700 Front bumper
- 701 Front lower valance/spoiler
- 702 Front grille
- 703 Hood edge and/or trim
- 704 Hood ornament (fixed)
- 705 Hood ornament (spring loaded)
- 706 Headlight
- 707 Retractable headlight door (Open/Closed)
- 708 Turn signal/parking lights
- 718 Other front or add on object
(specify): _____
- 719 Unknown front object

Left Side Components

- 720 Front fender side surface
- 721 Front antenna
- 722 A1 pillar
- 723 A2 pillar
- 724 B pillar
- 725 C pillar
- 726 D pillar
- 728 Other pillar
(specify): _____
- 729 Left side roof rail
- 730 Left side door surface
- 731 Left side door handle
- 732 Left side mirror fixed housing
- 733 Left side folding mirror
- 734 Left side glazing forward of B pillar
- 735 Left side glazing rearward of B pillar
- 736 Left side back fender or quarter panel
- 737 Rear antenna
- 738 Other left side object
(specify): _____
- 739 Unknown left side component

Right Side Components

- 740 Front fender side surface
- 741 Front antenna
- 742 A1 pillar
- 743 A2 pillar

- 744 B pillar
- 745 C pillar
- 746 D pillar
- 748 Other pillar (specify): _____
- 749 Right side roof rail
- 750 Right side door surface
- 751 Right side door handle
- 752 Right side mirror fixed housing
- 753 Right side folding mirror
- 754 Right side glazing forward of B pillar
- 755 Right side glazing rearward of B pillar
- 756 Rear antenna
- 757 Rear fender or quarter panel
- 758 Other right side object
(specify): _____
- 759 Unknown right side component

Back Components

- 760 Rear (back) bumper
- 761 Tailgate
- 762 Hatchback, vertical surface
- 768 Other back component
(specify): _____
- 769 Unknown back component

Top Components

- 770 Hood surface
- 771 Hood surface reinforced by under hood component
- 772 Front fender top surface
- 773 Cowl area
- 774 Wiper blade & mountings
- 775 Windshield glazing
- 776 Front header
- 777 Roof surface
- 778 Backlight glazing
- 779 Rear header
- 780 Hatchback
- 781 Rear trunk lid
- 788 Other top component (specify): _____
- 789 Unknown top component

Wheels / tires

- 790 Left front wheel / tire
- 791 Right front wheel / tire
- 792 Left rear wheel / tire
- 793 Right rear wheel / tire
- 798 Other wheel / tire (specify): _____
- 799 Unknown wheel / tire

Undercarriage components

- 800 Front cross member
- 801 Steering assembly/Front suspension
- 802 Oil pan
- 803 Exhaust system pipe
- 804 Transmission
- 805 Drive shaft
- 806 Catalytic converter
- 807 Muffler
- 808 Floor pan
- 809 Fuel tank
- 810 Rear suspension
- 818 Other undercarriage component
(specify): _____
- 819 Unknown undercarriage component

Accessories

- 820 Air scoop, deflector
- 821 Cellular or CB radio antenna
- 822 Emergency lights or bar
- 823 Fog lights
- 824 Luggage, ski, or bike rack
- 825 Cargo (specify): _____
- 826 Spare tire
- 827 Spotlight
- 828 Other accessory (specify): _____

Other Object or Vehicle in Environment

- 947 Ground
- 948 Other object (specify): _____
- 949 Unknown object in environment
- 959 Unknown object on contacting vehicle
- 997 Noncontact injury source
- 999 Unknown injury source

POINTS OF PEDESTRIAN CONTACT
PEDESTRIAN CONTACT WORKSHEET

CONTACT ID LABEL	COMPONENT CONTACTED	LONGITUDINAL LOCATION (X)	LATERAL LOCATION (Y)	CRUSH IN CENTIMETERS	SUSPECTED BODY REGION	SUPPORTING PHYSICAL EVIDENCE	CONFIDENCE LEVEL OF CONTACT POINT (Circle)	SEQUENCE #
1	Bumper	95	5	0	Legs	Streaks on top of Bumper	2 3 9	1
2	"	83	51	0	"	Smear	2 3 9	2
E	Hood Edge	86	0	0	Upper leg	Large smears area	1 2 3 9	3
A	"	77	31	15	Upper leg	"	1 2 3 9	4
H	Hood	47	22	15	"	"	1 2 3 9	3
D	Hood	100	-2	0	Riding Foot on hand	Curved smears	1 2 3 9	4
2	"	35	-17	5	"	"	2 3 9	4
6	Hood	27	25	0	ARM	Narrow	1 2 3 9	5
0	"	-7	22	15	"	Curving smears	1 2 3 9	5
9	"	-14	52	15	"	"	1 2 3 9	5
A	Hood	77	31	0	Bag on back	Long narrow streak	1 2 3 9	6
8	"	16	50		"	"	1 2 3 9	6
4	Hood	12	40	scratches	Upper leg	Long curving smears	1 2 3 9	7
b	"	-6	61	scratches	Backpack	Scratch	1 2 3 9	7
K	Top of Fender	0	75	15	"	"	2 3 9	7
J	"	-17	70	Bumps	end of contact	"	1 2 3 9	
G	Side Fender	-18	87	0	Upper Body	Side streaks smears	1 2 3 9	8
B	"	5	92	0	"	"	1 2 3 9	8
a	Hood	39	39	0	side swipe of leg	sidewipe smears	1 2 3 9	9
q	"	50	64	0	Riding Feet	"	1 2 3 9	9
							1 2 3 9	
							1 2 3 9	
							1 2 3 9	
							1 2 3 9	
							1 2 3 9	

same

yellow

yellow

white

white

white

white

POINTS OF PEDESTRIAN CONTACT							
CHRONOLOGICAL ORDER OF CONTACTS							
CONTACT #	COMPONENT CONTACTED CODE	LONGITUDINAL LOCATION (X)	LATERAL LOCATION (Y)	CRUSH IN CENTIMETERS	SUSPECTED BODY REGION	SUPPORTING PHYSICAL EVIDENCE	CONFIDENCE LEVEL OF CONTACT POINT (Circle)
1							1 2 3 9
2							1 2 3 9
3							1 2 3 9
4							1 2 3 9
5							1 2 3 9
6							1 2 3 9
7							1 2 3 9
8							1 2 3 9
9							1 2 3 9
10							1 2 3 9
11							1 2 3 9
12							1 2 3 9
13							1 2 3 9
14							1 2 3 9
15							1 2 3 9
16							1 2 3 9
17							1 2 3 9
18							1 2 3 9
19							1 2 3 9
20							1 2 3 9
21							1 2 3 9
22							1 2 3 9
23							1 2 3 9
24							1 2 3 9
25							1 2 3 9

Handwritten notes:
 Only injury
 15
 neck
 street

VEHICLE DIMENSIONS

4. Original Wheelbase 238
 _____ Code to the nearest centimeter
 (999) Unknown

93.7 inches X 2.54 = _____ centimeters

5. Original Average Track Width 140
 _____ Code to the nearest centimeter
 (185) 185 centimeters or more
 (999) Unknown

55.1 inches X 2.54 = 140 centimeters

6. Hood Material W
 (1) Plastic
 (2) Fiberglass
 (3) Steel
 (4) Aluminum
 (5) Stainless Steel
 (8) Other (specify): _____
 (9) Unknown

7. Hood Original 1
 Equipment Manufacturer (OEM)
 (1) OEM factory installed hood
 (2) OEM replacement
 (3) Non-OEM replacement
 (9) Unknown

8. Hood Length 099
 _____ Code to the nearest centimeter
 (180) 180 centimeters or more
 (999) Unknown

_____ inches X 2.54 = _____ centimeter

9. Hood Width Forward Opening 125
 _____ Code to the nearest centimeter
 (210) 210 centimeters or more
 (999) Unknown

_____ inches X 2.54 = _____ centimeters

10. Hood Width Midway 130
 _____ Code to the nearest centimeter
 (210) 210 centimeters or more
 (999) Unknown

_____ inches X 2.54 = _____ centimeters

11. Hood Width Rear Opening 132
 _____ Code to the nearest centimeter
 (210) 210 centimeters or more
 (999) Unknown

_____ inches X 2.54 = _____ centimeters

12. Hood/Fender Vertical/Lateral Crush From Pedestrian +
 (0) Not damaged
 (1) Surface scratching only, no residual crush
 (2) Minor crush (1-3 centimeters)
 (3) Moderate crush (4-7 centimeters)
 (4) Severe crush (>7 centimeters)
 (8) Damage present, unknown if damage is from pedestrian impact
 (9) Unknown

13. Windshield Contact Damage From Pedestrian Contact Q
 (0) Not contacted by pedestrian
 (1) Contacted by pedestrian - not damaged
 (2) Contacted by pedestrian - damaged
 (3) Unknown if contacted by pedestrian - not damaged
 (4) Unknown if contacted by pedestrian - damaged
 (9) Unknown if contacted by pedestrian - unknown if damaged

FRONT CONTACT DAMAGE

Front Vertical Measurements

14. Front Bumper Cover Material W
 (0) No front contact
 (1) Plastic
 (2) Fiberglass
 (3) Rubber
 (4) Other (specify): _____
 (9) Unknown

15. Front Bumper Reinforcement Material 1
 (0) No front contact
 (1) Steel
 (2) Aluminum
 (3) Stainless Steel
 (4) Other (specify): _____
 (9) Unknown

16. Front Bumper-Bottom Height 031
 _____ Code to the nearest centimeter
 (000) No front contact
 (150) 150 centimeters or more
 (999) Unknown

_____ inches X 2.54 = _____ centimeters

17. Front Bumper-Top Height 051
 _____ Code to the nearest centimeter
 (000) No front contact
 (150) 150 centimeters or more
 (999) Unknown
 _____ inches X 2.54 = _____ centimeters

18. Forward Hood Opening 057
 _____ Code to the nearest centimeter
 (000) No front contact
 (200) 200 centimeters or more
 (999) Unknown
 _____ inches X 2.54 = _____ centimeters

19. Front Bumper Lead 09
 (00) No front contact
 _____ Code to the nearest centimeter
 (30) 30 centimeters or more
 (99) Unknown
 _____ inches X 2.54 = _____ centimeters

23. Ground to Base of Windshield 178
 _____ Code to the nearest centimeter
 (000) No front contact
 (400) 400 centimeters or more
 (999) Unknown
 _____ inches X 2.54 = _____ centimeters

24. Ground to Top of Windshield 254
 _____ Code to the nearest centimeter
 (000) No front contact
 (500) 500 centimeters or more
 (999) Unknown
 _____ inches X 2.54 = _____ centimeters

25. Ground To Head Contact 998
 _____ Code to the nearest centimeter
 (000) No front contact
 (400) 400 centimeters or more
 (998) No head contact
 (999) Unknown
 _____ inches X 2.54 = _____ centimeters

Front Wrap Distance Measurements

SIDE CONTACT DAMAGE

Side Vertical Measurements

20. Ground to Forward Hood Opening 064
 _____ Code to the nearest centimeter
 (000) No front contact
 (200) 200 centimeters or more
 (999) Unknown
 _____ inches X 2.54 = _____ centimeters

21. Ground to Front/Top Transition Point 066
 _____ Code to the nearest centimeter
 (000) No front contact
 (180) 180 centimeters or more
 (999) Unknown
 _____ inches X 2.54 = _____ centimeters

22. Ground to Rear Hood Opening 170
 _____ Code to the nearest centimeter
 (000) No front contact
 (400) 400 centimeters or more
 (999) Unknown
 _____ inches X 2.54 = _____ centimeters

26. Ground Clearance 000
 _____ Code to the nearest centimeter
 (000) No side contact
 (150) 150 centimeters or more
 (999) Unknown
 _____ inches X 2.54 = _____ centimeters

27. Side Bumper-Bottom Height 000
 _____ Code to the nearest centimeter
 (000) No side contact
 (150) 150 centimeters or more
 (999) Unknown
 _____ inches X 2.54 = _____ centimeters

28. Side Bumper-Top Height 000
 _____ Code to the nearest centimeter
 (000) No side contact
 (150) 150 centimeters or more
 (999) Unknown
 _____ inches X 2.54 = _____ centimeters

29. Centerline of Wheel 000
 _____ Code to the nearest centimeter
 (000) No side contact
 (150) 150 centimeters or more
 (999) Unknown
 _____ inches X 2.54 = _____ centimeters

30. Top of Tire 000
 _____ Code to the nearest centimeter
 (000) No side contact
 (200) 200 centimeters or more
 (999) Unknown
 _____ inches X 2.54 = _____ centimeters

31. Top of Wheel Well Opening 000
 _____ Code to the nearest centimeter
 (000) No side contact
 (250) 250 centimeters or more
 (999) Unknown
 _____ inches X 2.54 = _____ centimeters

32. Bottom of A-Pillar at Windshield 000
 _____ Code to the nearest centimeter
 (000) No side contact
 (250) 250 centimeters or more
 (999) Unknown
 _____ inches X 2.54 = _____ centimeters

33. Top of A-Pillar at Windshield 000
 _____ Code to the nearest centimeter
 (000) No side contact
 (300) 300 centimeters or more
 (999) Unknown
 _____ inches X 2.54 = _____ centimeters

34. Top of Side View Mirror 000
 _____ Code to the nearest centimeter
 (000) No side contact
 (300) 300 centimeters or more
 (999) Unknown
 _____ inches X 2.54 = _____ centimeters

Side Lateral Measurements

35. Centerline to A-Pillar at Bottom of Windshield 000
 (000) No side contact
 _____ Code to the nearest centimeter
 (250) 250 centimeters or more
 (999) Unknown
 _____ inches X 2.54 = _____ centimeters

36. Centerline to A-Pillar at Top of Windshield 000
 _____ Code to the nearest centimeter
 (000) No side contact
 (250) 250 centimeters or more
 (999) Unknown
 _____ inches X 2.54 = _____ centimeter

37. Centerline to Maximum Side View Mirror Protrusion 000
 _____ Code to the nearest centimeter
 (000) No side contact
 (300) 300 centimeters or more
 (999) Unknown
 _____ inches X 2.54 = _____ centimeter

Side Wrap Distance Measurements

38. Ground to Side/Top Transition 000
 _____ Code to the nearest centimeter
 (000) No side contact
 (400) 400 centimeters or more
 (999) Unknown
 _____ inches X 2.54 = _____ centimeters

39. Ground to Hood Edge 000
 _____ Code to the nearest centimeter
 (000) No side contact
 (500) 500 centimeters or more
 (999) Unknown
 _____ inches X 2.54 = _____ centimeters

40. Ground to Centerline of Hood

000

Code to the nearest centimeter

- (000) No side contact
- (700) 700 centimeters or more
- (999) Unknown

_____ inches X 2.54 = _____ centimeters

41. Ground to Head Contact

000

Code to the nearest centimeter

- (000) No side contact
- (800) 800 centimeters or more
- (998) No head contact
- (999) Unknown

_____ inches X 2.54 = _____ centimeters

Final

B2601P00000011 969.0000000000000011450010000 96 96 96 96 96000000000
 00000000000000 01
 B2601P00010012 969.00100000000000101F72000
 B2601P00010021 9.00 0000000001321474608312703411013012306040109600142009702
 1010000000002
 B2601P00010131 9.00 00000000076402781699713000
 B2601P00010231 9.00 00000000077902021294711000
 B2601P01000041 9.00 000000000924904202JT2EL45F1N 99904809600094000000
 81141015011131413211211
 B2601P01000051 9.00 0000000002381403109912513013210310310510570906406617017
 8254998000
 B2601P9999999900
 00000000000000

PSUB2
 CASE 601P
 CURRENT VERSION: 9.00

ERROR SUMMARY SCREEN
 PEDESTRIAN STUDY

/96

FORM NAME	NUMBER OF DOLLAR SIGNS	NUMBER OF LEVEL 1 ERRORS	NUMBER OF LEVEL 2 ERRORS	VERSION NUMBER CONSISTENT
Pedestrian Accident	0	0	0	Y
Pedestrian Assessment	0	0	0	Y
Pedestrian Injury	0	0	0	Y
Pedestrian General Vehicle	0	0	0	Y
Pedestrian Exterior Vehicle	0	0	0	Y
Total Inter Errors		0	0	
Total Case Errors	0	0	0	